

Front View
Scale 1:1.5

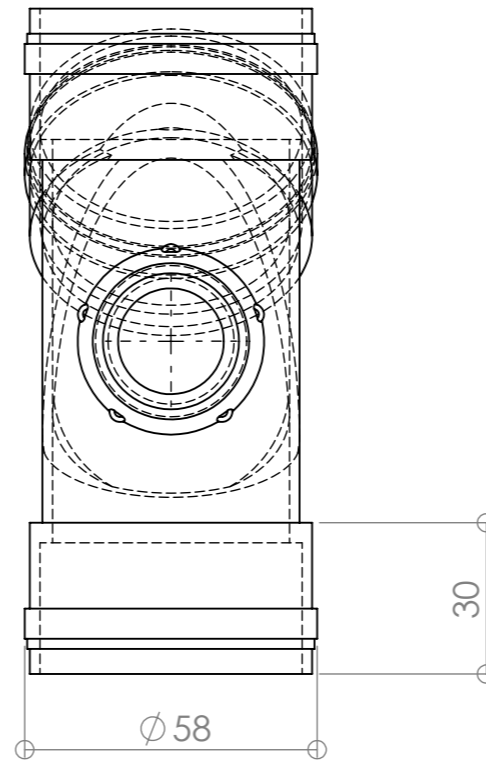

Side View
Scale 1:1.5

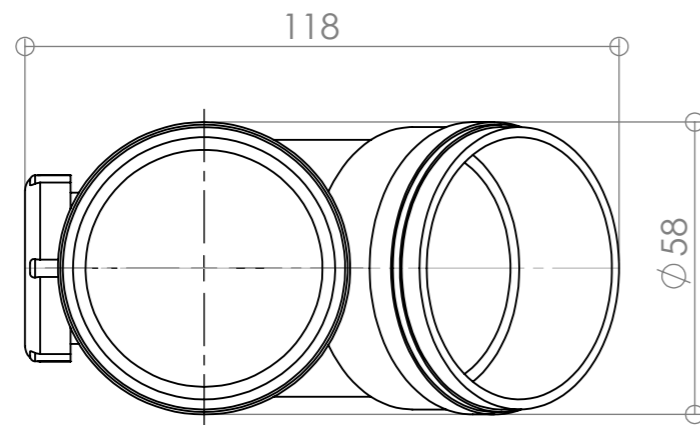

Top View
Scale 1:1.5

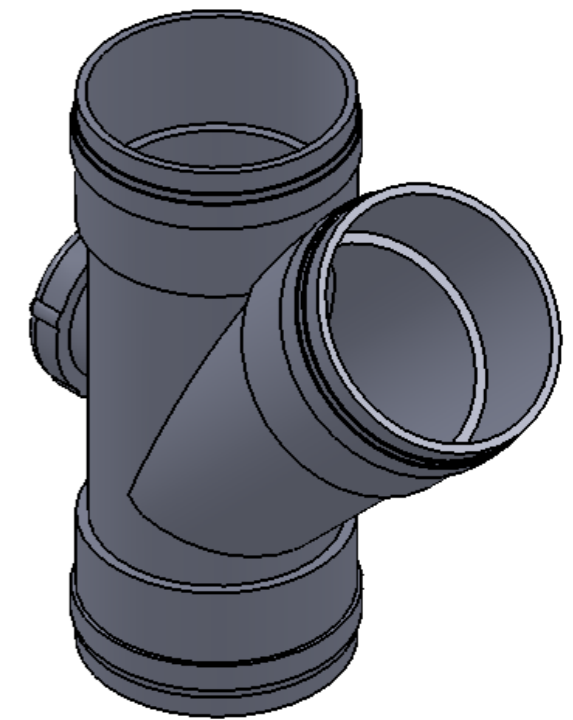

Isometric View
Scale 1:1.5

UNLESS OTHERWISE SPECIFIED: DIMENSIONS ARE IN MILLIMETERS SURFACE FINISH: TOLERANCES: LINEAR: ANGULAR:				FINISH:		DEBUR AND BREAK SHARP EDGES		DO NOT SCALE DRAWING		REVISION	
				DRAWN		SIGNATURE		DATE		TITLE:	
CHK'D											
APPV'D											
MFG											
Q.A						MATERIAL:		DWG NO.		A3	
						WEIGHT:		SCALE:1:2		SHEET 1 OF 1	

W50SJ,090