

Front View
Scale 1:1

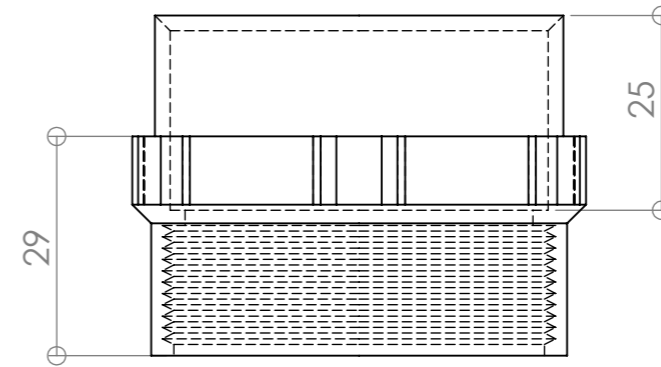

Side View
Scale 1:1

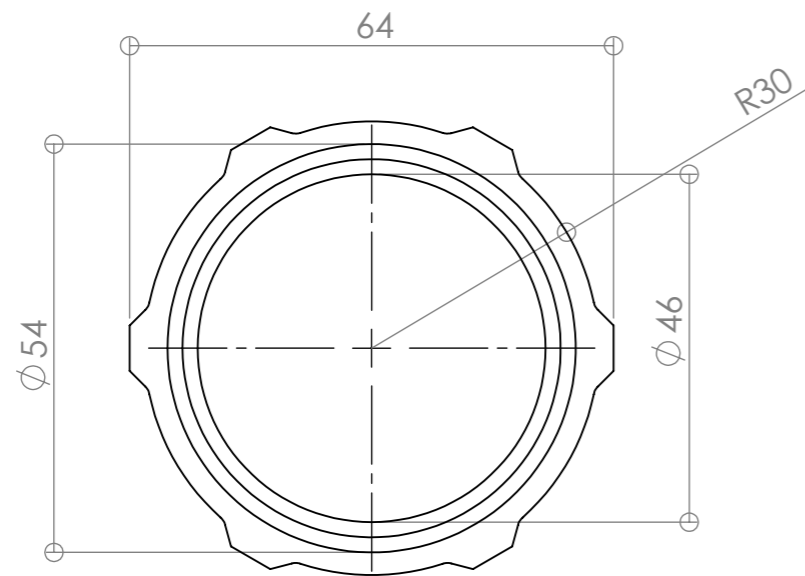

Top View
Scale 1:1

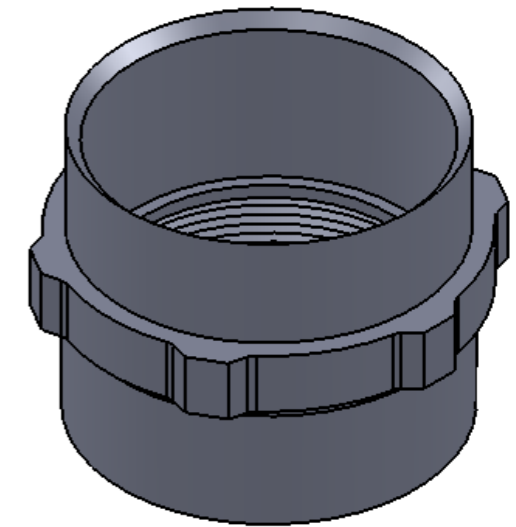

Isometric View

UNLESS OTHERWISE SPECIFIED: DIMENSIONS ARE IN MILLIMETERS SURFACE FINISH: TOLERANCES: LINEAR: ANGULAR:				FINISH:		DEBUR AND BREAK SHARP EDGES		DO NOT SCALE DRAWING		REVISION	
DRAWN				NAME		SIGNATURE		DATE		TITLE:	
CHK'D											
APPV'D											
MFG											
Q.A								MATERIAL:		DWG NO. W50FAD,090	
								WEIGHT:		SCALE:1:1	
										SHEET 1 OF 1	
										A3	