

Front View
Scale 1:2

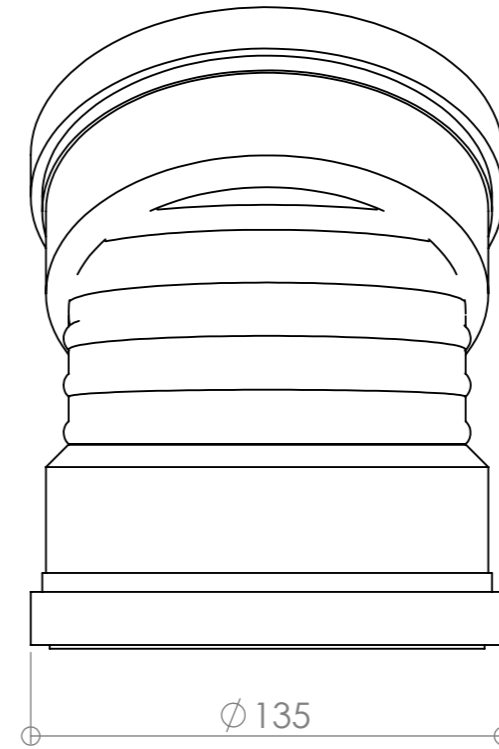

Side View
Scale 1:2

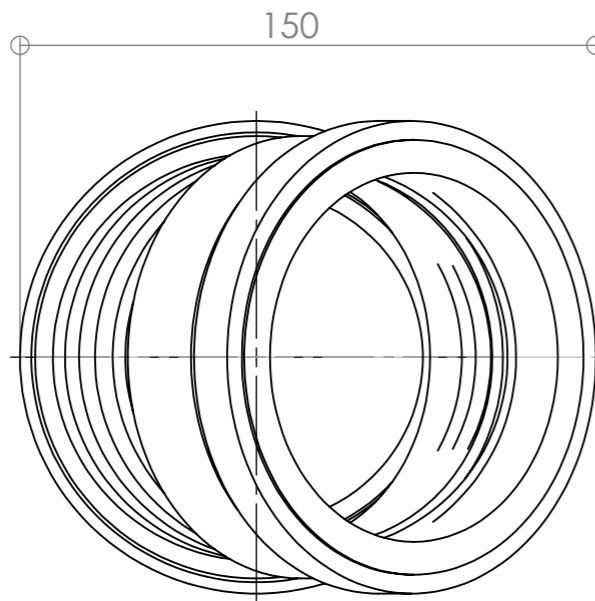

Top View
Scale 1:2



Isometric View

UNLESS OTHERWISE SPECIFIED: DIMENSIONS ARE IN MILLIMETERS SURFACE FINISH: TOLERANCES: LINEAR: ANGULAR:				FINISH:		DEBUR AND BREAK SHARP EDGES		DO NOT SCALE DRAWING		REVISION	
DRAWN				SIGNATURE		DATE		TITLE:			
CHK'D											
APPV'D											
MFG											
Q.A						MATERIAL:		DWG NO.		A3	
						WEIGHT:		SCALE:1:2		SHEET 1 OF 1	
								C110SBP,720			